

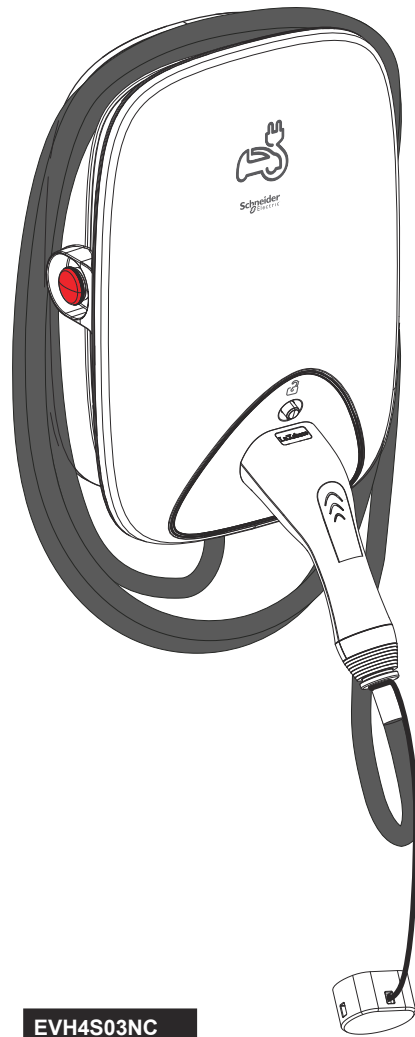

- EVH4S03N2
- EVH4S07N2
- EVH4S11N2
- EVH4A03N2
- EVH4A07N2
- EVH4A11N2



- EVH4S03NC
- EVH4S07NC
- EVH4S11NC
- EVH4A03NC
- EVH4A07NC
- EVH4A11NC

Customer Care Center



Safety..... 3

1 Contents..... 4

2 Description..... 5

2.1 Product References 5

2.2 Dimensions and Weight 5

2.3 Product Description 5

3 Characteristics 7

3.1 General Data 7

3.2 Certification..... 7

3.3 Environnement..... 7

3.4 Accessories..... 7

4 Protection..... 7

Upstream Protections 7

Power Cable Requirements..... 7

5 Wiring 8

6 Connection..... 8

6.1 Undervoltage Release (MNx) 8

6.2 Wire-up Power Supply 9

6.3 Ethernet Port Connection (Optional for EVlink Home Smart Charging Station) 11

6.4 RS485 Port Connection (Optional for EVlink Home Smart Charging Station)..... 11

6.5 Secure Inspection Hatch..... 11

6.6 Clamp Power Cable..... 12

7 Installation 13

7.1 Mark Installation Area 13

7.2 Drill, Fix and Mount..... 14

8 Inspection 14

9 Configuration 15

10 Cable Storage 15

11 eSetup Commisioning App (For EVlink Home Smart Charging Station) 16

11.1 Charging Station Configuration with eSetup for Electrician App..... 16

11.2 Commissioning Steps 16

11.3 Charging Station PIN code reset 16

12 Operation 17

12.1 Connecting the Electric Vehicle Charging Station 17

12.2 Disconnecting the Electric Vehicle..... 17

12.3 Remote supervision with Wiser (For EVlink Home Smart Charging Station) 17

13 Charging Station Status Indicators 18

14 Basic Troubleshooting..... 18

15 Wireless Feature Declaration 18

16 Recycle 18

17 Warranty 18

The Schneider Electric brand and any trademarks of Schneider Electric SE and its subsidiaries referred to in this guide are the property of Schneider Electric SE or its subsidiaries. All other brands may be trademarks of their respective owners.

This guide and its content are protected under applicable copyright laws and furnished for informational use only. No part of this guide may be reproduced or transmitted in any form or by any means electronic, mechanical, photocopying, recording, or otherwise), for any purpose, without the prior written permission of Schneider Electric.

Schneider Electric does not grant any right or license for commercial use of the guide or its content, except for a non exclusive and personal license to consult it on an «as is» Schneider Electric products and equipment should be installed, operated, serviced, and maintained only by qualified personnel.

As standards, specifications, and designs change from time to time, information contained in this guide may be subject to change without notice.

To the extent permitted by applicable law, no responsibility or liability is assumed by Schneider Electric and its subsidiaries for any errors or omissions in the informational content of this material or consequences arising out of or resulting from the use of the information contained herein.

Safety

Important Information



Read these instructions carefully, and look at the equipment to become familiar with the device before trying to install, operate, or maintain it. The following special messages may appear throughout this documentation or on the equipment to warn of potential hazards or to call attention to information that clarifies or simplifies a procedure.



The addition of this symbol to a «Danger» or «Warning» safety label indicates that an electrical hazard exists which will result in personal injury if the instructions are not followed.



This is the safety alert symbol. It is used to alert you to potential personal injury hazards. Obey all safety messages that follow this symbol to avoid possible injury or death.

▲ DANGER

DANGER indicates a hazardous situation which, if not avoided, **will result** in death or serious injury.

▲ WARNING

WARNING indicates a hazardous situation which, if not avoided, **could result** in death or serious injury.

▲ CAUTION



CAUTION indicates a hazardous situation which, if not avoided, **could result** in minor or moderate injury.

NOTICE

NOTICE is used to address practices not related to physical injury.





PLEASE NOTE

- The installation, maintenance and eventual replacement of this device must only be carried out by a qualified electrician.
- This device must not be repaired.
- All applicable local, regional and national regulations must be complied with during the installation, use, maintenance and replacement of this device.
- This device should not be installed if, when unpacking it, you observe that it is damaged.
- Schneider Electric cannot be held responsible in the event of non-compliance with the instructions in this document and in the documents to which it refers.
- The service instruction must be observed throughout the life time of this device.

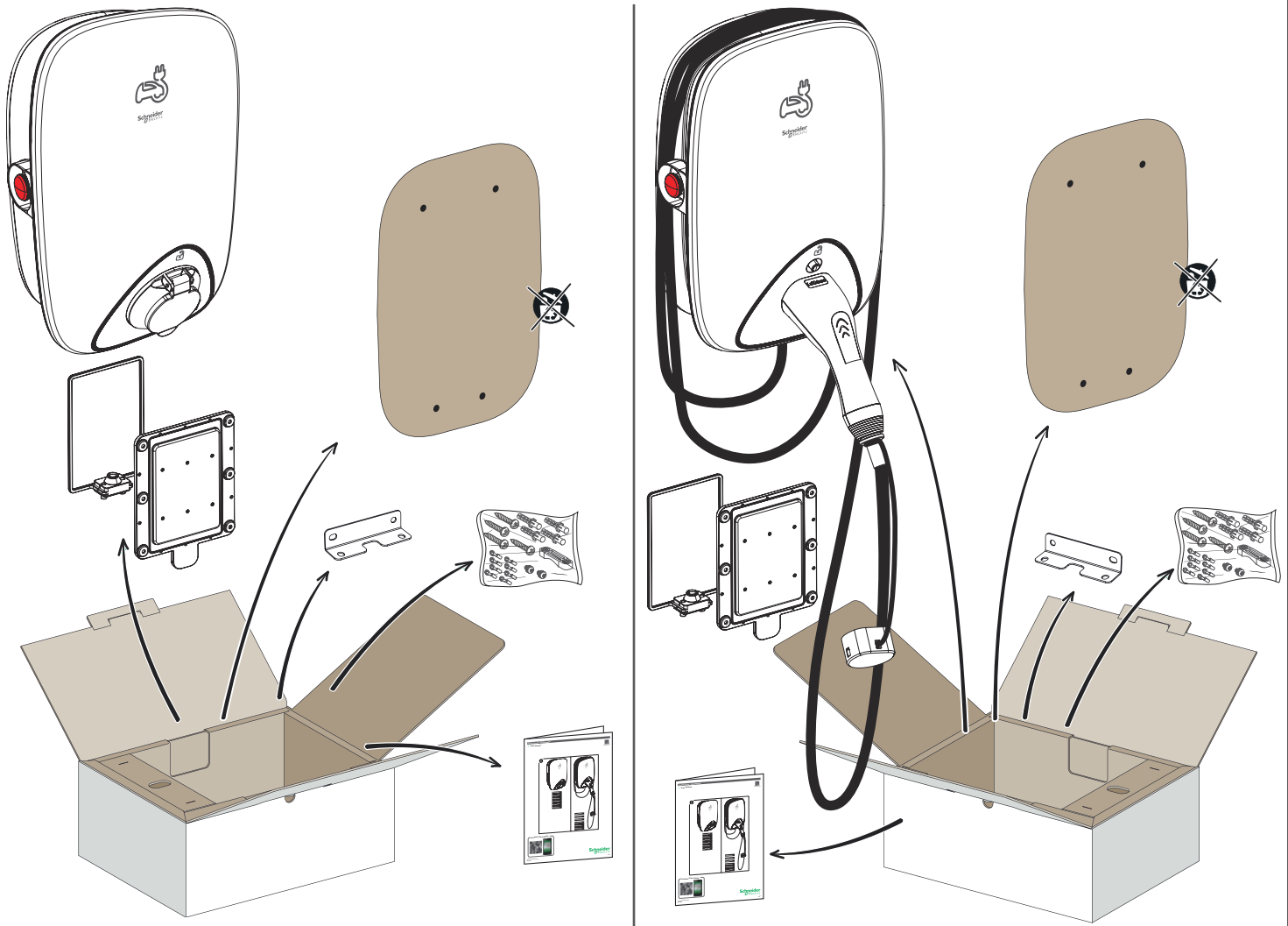
Symbol	Content
	<p>Electrical hazard</p> <ul style="list-style-type: none"> □ The equipment must be installed, commissioned, serviced, and maintained only by qualified personnel. □ The installation should comply with existing standards and local regulations. □ See section "Installation" page 13 for details. <p>Electrical hazard / fire hazard</p> <ul style="list-style-type: none"> □ The charging station, the cable and the connector must be regularly checked by to detect any potential damage (visual inspection). □ In case the charging station is damaged, it must be immediately turned off and replaced. □ Do not perform any maintenance work on the equipment. □ Do not open or modify the charging station. □ Do not remove signs such as safety symbols, warnings, nameplates, signs or markings. ■ Do not use any extension cable to connect the charging station to the electric vehicle. ■ Do not connect any other type of loads to the charging station (power tools, etc.). Only connect electric vehicles or their charging equipment. ■ Do not disconnect the connector by pulling the cable. Hold the connector in your hand to disconnect the connector from the electrical vehicle. ■ Do not bend, squeeze or tilt the connector so that it is mechanically damaged. ■ Prevent the connector to be in contact with heat source, dirt or water. ■ When using an integrated charging station to charge your electric car, please read the vehicle's tips and instructions carefully. <p>Failure to follow safety instructions can result in death, injury, and equipment damage.</p>
	<ul style="list-style-type: none"> ■ Never clean the charging point by spraying it with water (Hose for garden watering, high pressure cleaners, etc)

1 Contents



	M8x60 mm (5/16 x 2.36 in) wall plugs x 4
	M6x50 mm (15/64 x 1.97 in) screws x 4
	M6x12 mm (15/64 x 0.47 in) screws x 2
	1 phase: ring terminals x 3 3 phase: ring terminals x 5
	Crimping collar x 1

2 Description

2.1 Product References

Reference	Short Description	Power supply	Power rating	Electrical protection
EVH4S03N2	EVlink Home 1P T2 3.7 kW 16A - with RDC-DD	T2 socket	3.7 kW 16A	with 6 mA RDC-DD filter
EVH4S07N2	EVlink Home 1P T2 7.4 Kw 32A - with RDC-DD	T2 socket	7.4 kW 32A	with 6 mA RDC-DD filter
EVH4S11N2	EVlink Home 3P T2 11 kW 16A - with RDC-DD	T2 socket	11 kW 16A	with 6 mA RDC-DD filter
EVH4S03NC	EVlink Home 1P attached cable 5 m 3.7 kW 16A - with RDC-DD	Attached cable 5 m / 16.4ft	3.7 kW 16A	with 6 mA RDC-DD filter
EVH4S07NC	EVlink Home 1P attached cable 5 m 7.4 Kw 32A - with RDC-DD	Attached cable 5 m / 16.4ft	7.4 kW 32A	with 6 mA RDC-DD filter
EVH4S11NC	EVlink Home 3P attached cable 5 m 11 kW 16A - with RDC-DD	Attached cable 5 m / 16.4ft	11 kW 16A	with 6 mA RDC-DD filter
EVH4A03N2	EVlink Home Smart 1P T2 3.7 kW 16A - with RDC-DD	T2 socket	3.7 kW 16A	with 6 mA RDC-DD filter
EVH4A07N2	EVlink Home Smart 1P T2 7.4 Kw 32A - with RDC-DD	T2 socket	7.4 kW 32A	with 6 mA RDC-DD filter
EVH4A11N2	EVlink Home Smart 3P T2 11 kW 16A - with RDC-DD	T2 socket	11 kW 16A	with 6 mA RDC-DD filter
EVH4A03NC	EVlink Home Smart 1P attached cable 5m 3.7 kW 16A - with RDC-DD	Attached cable 5 m / 16.4ft	3.7 kW 16A	with 6 mA RDC-DD filter
EVH4A07NC	EVlink Home Smart 1P attached cable 5m 7.4 Kw 32A - with RDC-DD	Attached cable 5 m / 16.4ft	7.4 kW 32A	with 6 mA RDC-DD filter
EVH4A11NC	EVlink Home Smart 3P attached cable 5m 11 kW 16A - with RDC-DD	Attached cable 5 m / 16.4ft	11 kW 16A	with 6 mA RDC-DD filter

2.2 Dimensions and Weight

Model	EVH4S03N2, EVH4S07N2 (Charging station with T2 socket: socket, type T2) EVH4S03NC, EVH4S07NC (Charging station with charging cable: cable, type T2) EVH4A03N2, EVH4A07N2 (Smart charging station with T2 socket: socket, type T2) EVH4A03NC, EVH4A07NC (Smart charging station with charging cable: cable, type T2)	EVH4S11N2 (Charging station with T2 socket: socket, type T2) EVH4S11NC (Charging station with charging cable: cable, type T2) EVH4A11N2 (Smart charging station with T2 socket: socket, type T2) EVH4A11NC (Smart charging station with charging cable: cable, type T2)
Power rating	3.7 and 7.4 kW	11 kW
Dimensions	282 mm × 409 mm × 148 mm / 11.1 in × 16.1 in × 5.83 in	
Weight	T2 socket: approx. 3.7 kg / 8.15 lb. Attached cable: approx. 5.2 kg / 11.46 lb	
Installation	Wall-mounted	

2.3 Product Description

- This charging station is an electrical appliance that supplies electric energy to charge plug-in electric vehicles for indoor and private outdoor areas.
- When installing and using the charging station, ensure that you comply with local regulations.
- The intended use of the equipment includes, in all cases, the environmental conditions established for the equipment.

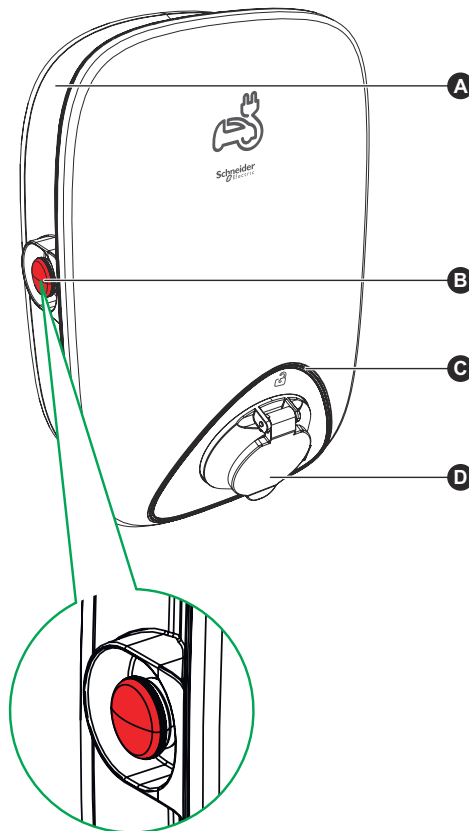

A	Cable winding trough	When not in use, wind the charging cable around the charging station's trough to avoid tripping hazards and equipment damage.
B	Stop button	Only to be used in an emergency. In normal use, stop the charge via the Electric Vehicle. The button can be reset by rotating it 90° clockwise.
C	LED status indicator	Indicates the status of the charging station and charging session, Section "Charging station Status Indicators", page 18.
D	Charging socket	Plug in your T2 charging cable

2 Description

2.3 Product Description

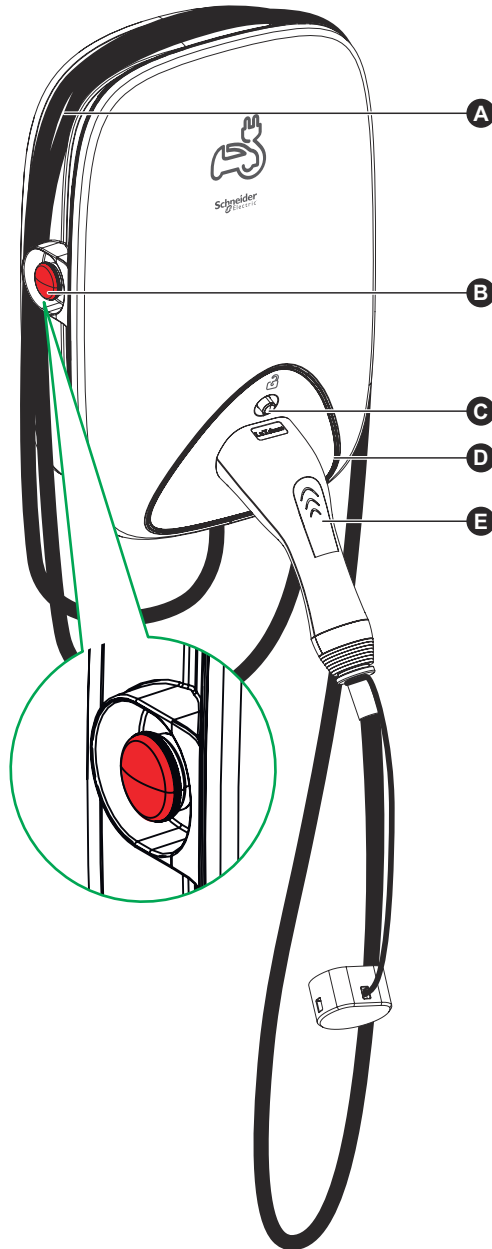

A	Cable winding trough	When not in use, wind the charging cable around the charging station's trough to avoid tripping hazards and equipment damage.
B	Stop button	Only to be used in an emergency. In normal use, stop the charge via the Electric Vehicle. The button can be reset by rotating it 90° clockwise.
C	Connector unlock button	Push the button to unlock the charging connector.
D	LED status indicator	Indicates the status of the charging station and charging session, Section "Charging station Status Indicators", page 18.
E	Charging connector dock	Dock the charging connector when not in use to avoid tripping hazards and equipment damage.

3 Characteristics

3.1 General Data

- Ingress protection rating: according to IEC 60529
 - IP54 for EVlink Home with T2 socket
 - IP55 for EVlink Home with attached cable
- Impact protection rating: IK10 (IEC 62262)
- Socket for T2 cable or T2 attached cable according to IEC 62196-1 and IEC 62196-2
- Operating temperature: -30°C to +50°C (-22°F to +122°F)
- Storage temperature: -40°C to +80°C (-40°F to +176°F)
- Relative humidity: 5-95 %
- Rated voltage (depending on model):
 - For 3.7 and 7.4 kW: 220~240V AC, 50 Hz
 - For 11 kW: 380~415V AC, 50 Hz
- Rated charging current: 16 A for 3.7 kW, 32 A for 7.4 kW and 16 A for 11 kW
- Accuracy of current, voltage and power measurement: 1%
- Diagram of the earthing system: TN-S, TN-C-S, TT, IT (230V)
- Designed for indoor and outdoor use
- OCPP 1.6J (Smart version only)
- Wi-Fi feature 2.4 GHz (Smart version only)
 - Operating frequency bands: 2412MHz – 2472MHz
 - Maximal RF output power: less than 20 dBm (18.25dBm)
- 1 Ethernet port (Smart version only)
- 1 RS485 port (Smart version only)

3.2 Certification

- IEC/EN 61851-1 ed 3.0
- IEC 61851-21 - 2
- IEC 62955-2018
- EN 61000-6-1
- EN 61000-6-3

3.3 Environment

- Compliant with the RoHS European directive
- Compliant with the REACH European regulation

3.4 Accessories

- EVlink Home Anti-tripping module, single-phase (EVA1HPC1)
- EVlink Home Anti-tripping module, three-phase (EVA1HPC3)

Notes:

- The Anti-Tripping Module limits the power draw of the EVlink Home charging station, **in some cases completely stopping the charging**, to ensure the continuity of the home electrical supply. Refer to the Anti-tripping module's instruction sheet.

4 Protection

⚠ ⚠ DANGER

HAZARD OF ELECTRIC SHOCK, EXPLOSION OR ARC FLASH

Do not install automatic reset systems on the residual current protection device.

Failure to follow these instructions will result in death or serious injury.

Upstream Protections

- The Electric Vehicle measures the earth resistance and will only start charging if it is lower than the threshold defined by the Electric Vehicle manufacturer. Refer to the vehicle's technical documentation.
- The choice of electrical protections and wire gauges must comply with local regulations and the information below as well as the constraints of the electrical installation. In particular, the selected protection must not only satisfy the requirements of IEC 61851-1 ed 3.0 but must also limit the value of I^2t to less than 75 000 A²s in case of a short-circuit.

Charging station rated current	16 A 1-Ph	32 A 1-Ph	16 A 3-Ph
Protection against overload and short circuits	20 A curve B or C (1)	40 A curve B or C (1)	20 A curve C
Differential protection	30 mA type A	30 mA type A	30 mA type A

(1) According to selectivity with upstream protections

Recommended protection: Acti9 iC60

- A Undervoltage release (MNx) controlled by the charging station must be installed to enable to activate the upstream circuit-breaker tripping.
- The protections described below should only be taken as suggestions and Schneider Electric cannot be held liable.

Recommendations for lightning protection

One surge arrester per charging station is recommended for high keraunic levels, mandatory if required by local regulations.

Power Cable Requirements

- For wiring section "Wiring", page 8, please comply with local regulations.
- The maximum wire gauge should **not exceed 6 mm²** (AWG 9).
- Two types of wire as recommended when connecting the charging station to the power supply:
 - To use flexible cables with ring terminal and crimp ring terminals.
 - To use rigid cable.

1-phase installations

	Distribution board - EVlink Home and EVlink Home Smart	EVlink Home and EVlink Home Smart - Undervoltage Release (MNx)
Diameter	3 x 6 mm ² (3 x AWG 9) (Type U1000R2V 3G)	2 x 0.5 mm ² (2 x AWG 20)
Length	< 50 meters (164.04 ft)	< 30 meters (98.43 ft)

3-phase installations

	Distribution board - EVlink Home and EVlink Home Smart	EVlink Home and EVlink Home Smart - Undervoltage Release (MNx)
Diameter	5 x 6 mm ² (5 x AWG 9) (Type U1000R2V 5G)	2 x 0.5 mm ² (2 x AWG 20)
Length	< 50 meters (164.04 ft)	< 30 meters (98.43 ft)

TN/TT Earthing System Wiring

1-phase

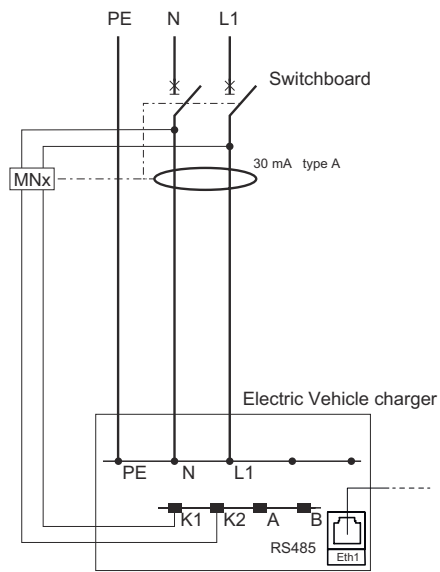

3-phase

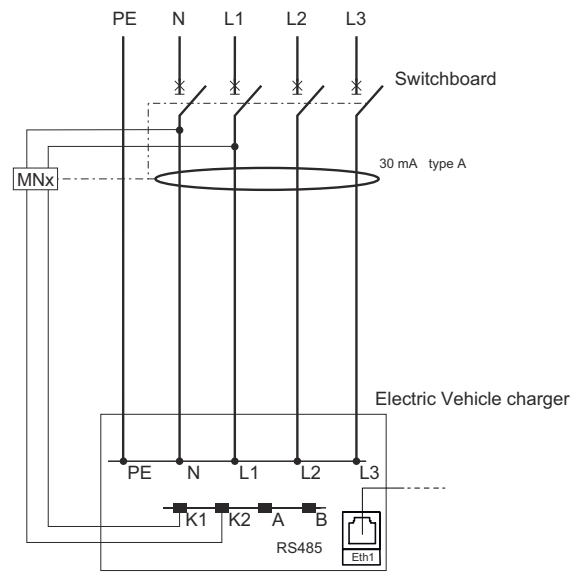

IT Earthing System Wiring 230V only

1-phase

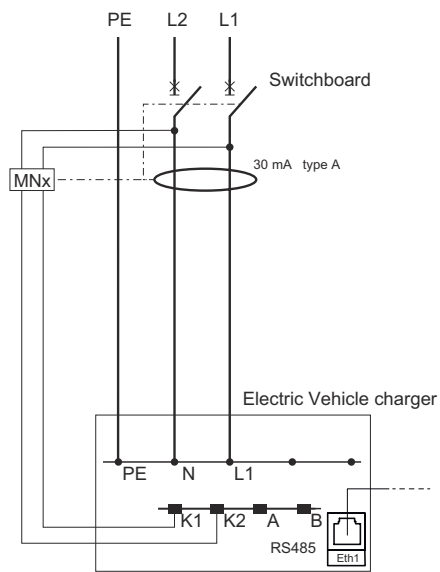

3-phase

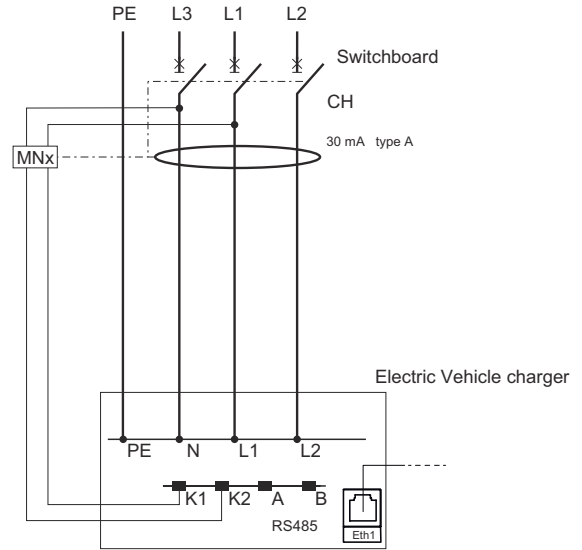

MNx: Undervoltage release

⚠️ ⚠️ DANGER

HAZARD OF ELECTRIC SHOCK, EXPLOSION OR ARC FLASH

- Disconnect the mains power supply before working on the charging station.
 - Use a Voltage Tester of appropriate rating.
 - Do not turn on the charging station if the earth resistance measured is higher than the threshold defined in the enforceable regulations.
 - Connection to a Undervoltage release (MNx). It is not supplied with the charging station.
 - Do not connect to an IT earthing system if the voltage exceeds 240Vac
- Failure to follow these instructions will result in death or serious injury.**

6.1 Undervoltage Release (MNx)

- Install a Undervoltage release (MNx) as described in the wiring diagram (section "Wiring", page 8) to increase operator safety with IEC 61851-1.
- Connect the Undervoltage release (MNx) with 0.5 mm² (20 AWG) 2-core cable with insulation for 220~240 V no wider than 5 mm.
- Take the rubber gasket and poke out 1 of the 2 rubber plugs.
- Pass the 2 wires connecting the Undervoltage release (MNx) through the now empty plug.
- Inside the EVlink Home charging station, insert 1 wire from the Undervoltage release (MNx) into the K2 terminal of the connector (insert thin screwdriver into connector's largest hole and push down to open clamp).
- Insert the other end into the K1 terminal of the connector (insert thin screwdriver into connector's largest hole and push down to open clamp).

TN/TT Earthing System Wiring

1-phase EVlink Charger

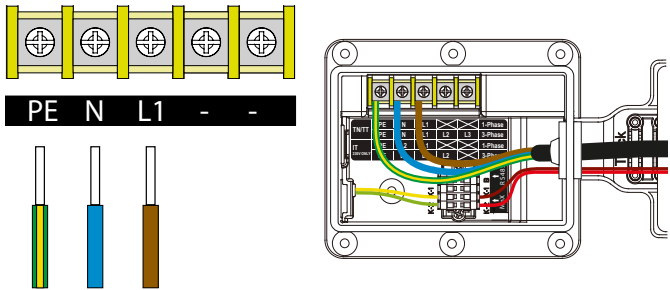
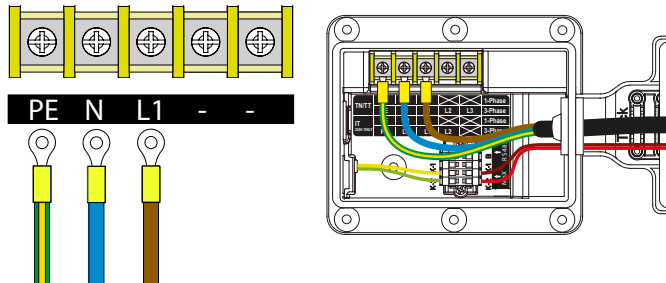

3-phase EVlink Charger

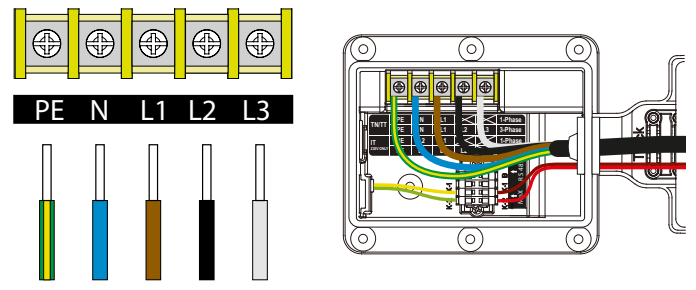
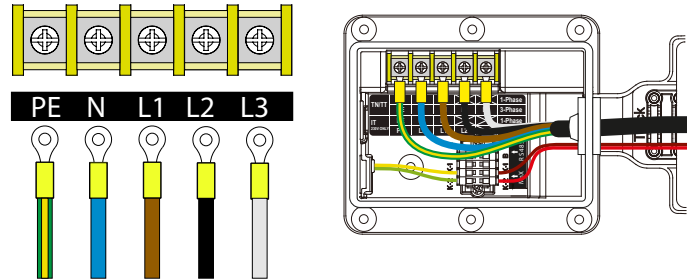

IT Earthing System Wiring 230V only

1-phase EVlink Charger

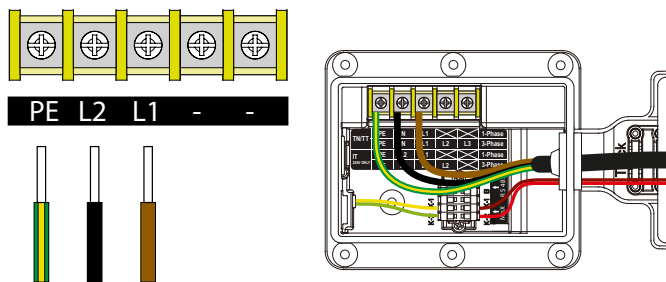
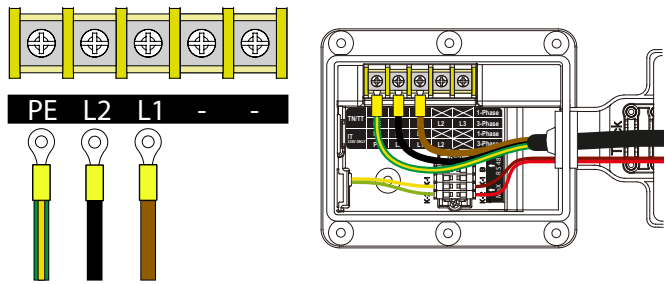

3-phase EVlink Charger

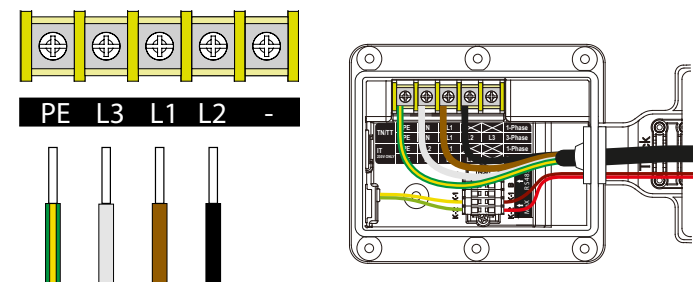
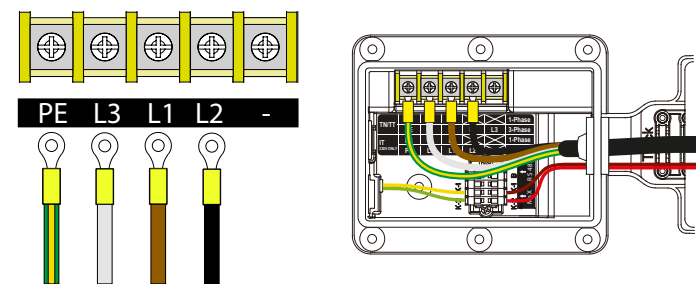

6 Connection

6.2 Wire-up Power Supply

Flexible cable with ring terminal connection

3G6 (Single phase)
5G6 (Three phase)

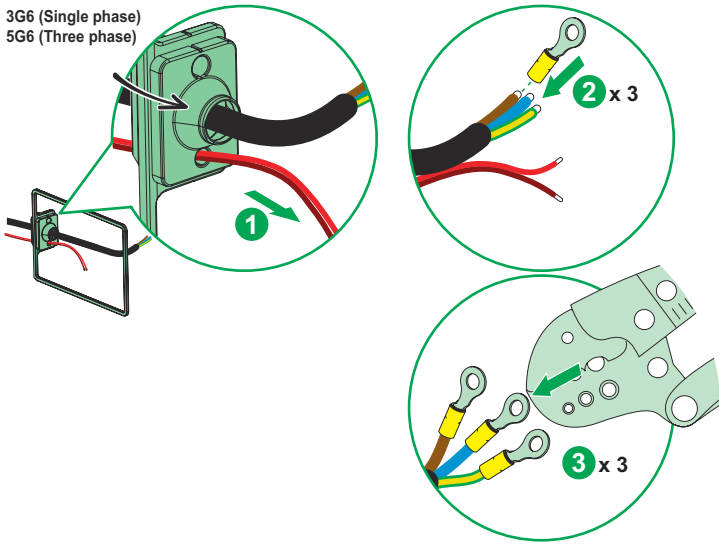

Rigid cable connection

3G6 (Single phase)
5G6 (Three phase)

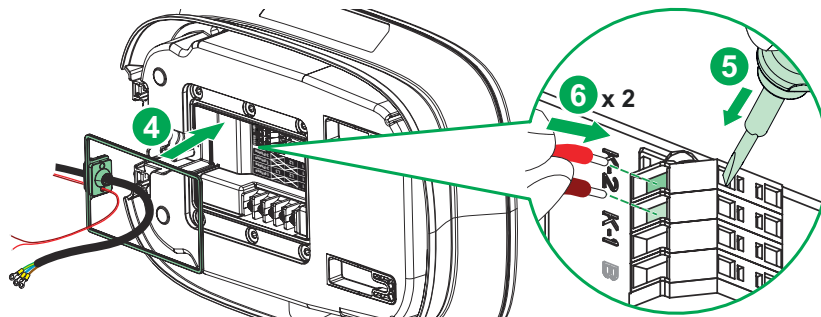
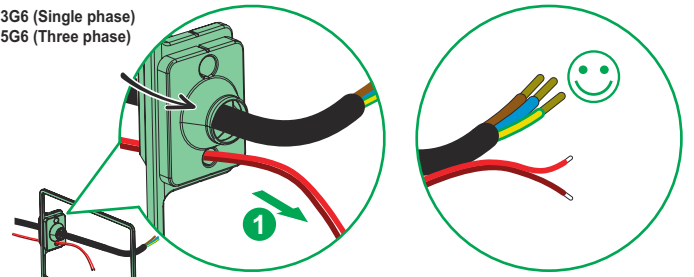

Flexible cable with ring terminal connection

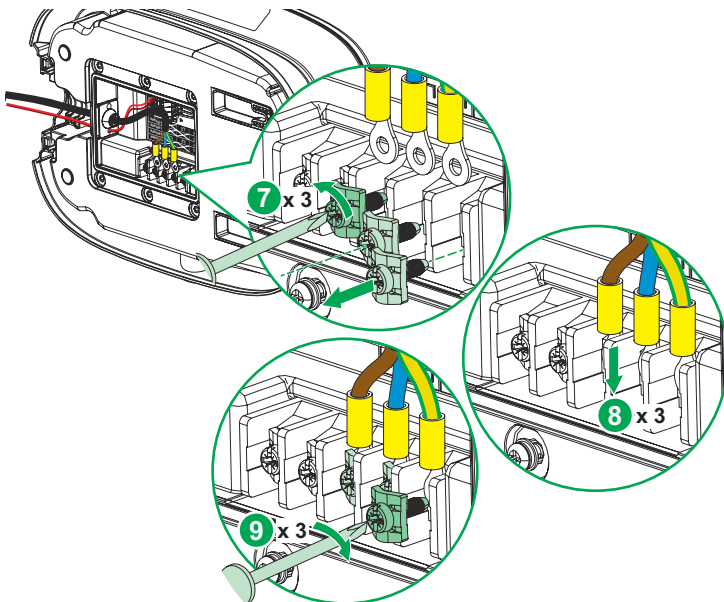

Rigid cable connection

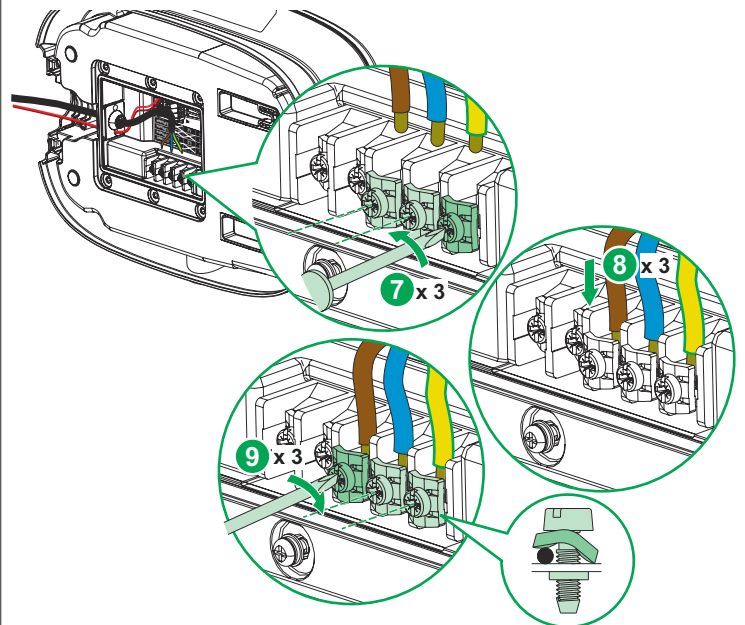

Cable connection type	Cable section	N.m	⊕ ⊖	⚡
Flexible cable with Ring terminal	2.5 - 6 mm ² AWG 13.2 - 9.4	1.7 N.m 15.04 lb-in	PH2 / PZ2	8 mm 0.31 in
Rigid cable	2.5 - 6 mm ² AWG 13.2 - 9.4			13 mm 0.51 in

6 Connection

6.3 Ethernet Port Connection (Optional for EVlink Home Smart Charging Station)

- When installing the EVlink Home Smart charging station, it is recommended to prepare the Ethernet connection in advance.
- Refer to the following procedure. Plug the Ethernet connector into the Ethernet port.

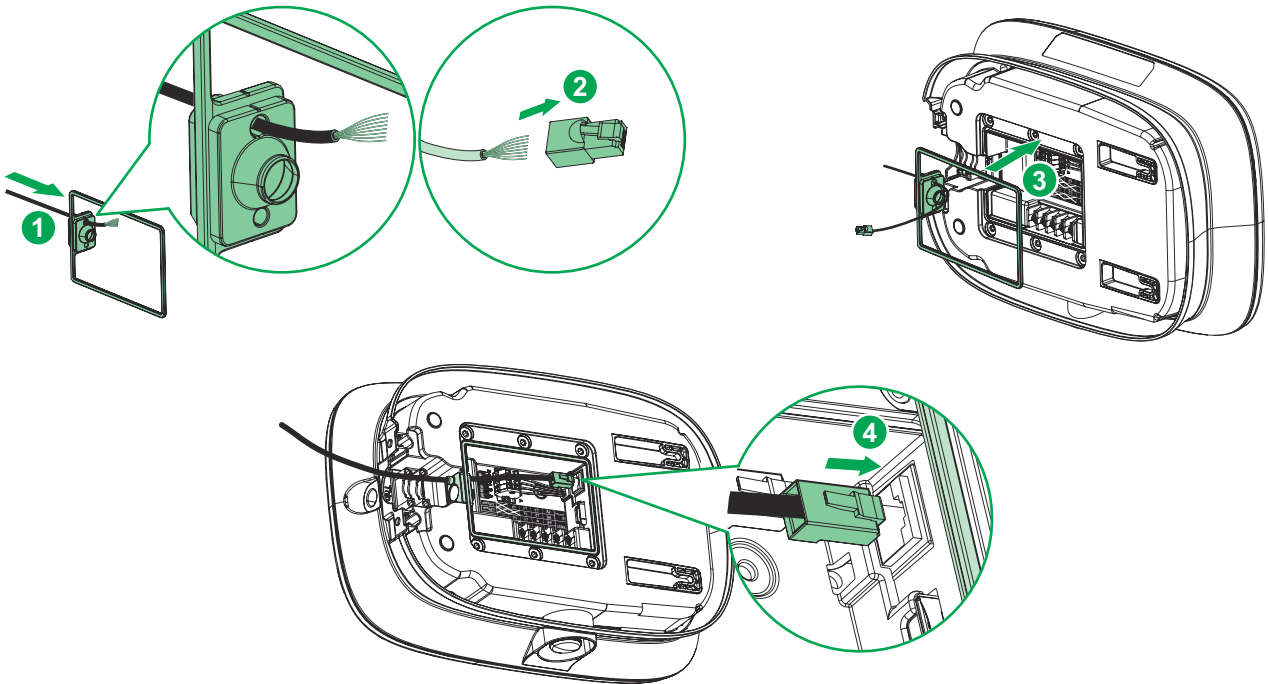

Note:

For EVlink Home Smart charging stations, an Ethernet cable connection is preferred over a Wi-Fi connection if the charging station is installed outside or in a garage that does not have an Internet box/router or Wi-Fi repeater. If an Ethernet cable connection is not practical it is recommended to install a Wi-Fi repeater close to the charging station.

6.4 RS485 Port Connection (Optional for EVlink Home Smart Charging Station)

- When installing EVlink Home Smart charging station, consider whether to do RS485 connection for Certified Power Meter (MID) in advance.
- If needed, follow below connection guide procedures. Connect RS485 wire 1 x 0.5 mm² (1 x 20 AWG) with positive (+) data into A terminal, connect RS485 wire 1 x 0.5 mm² (1 x 20 AWG) with negative (-) data into B terminal. Refer to Energy Meter (MID) instruction sheet, do not reverse the RS485 wire connection.
- Energy Meter (MID) references: A9MEM2155, A9MEM3155.
 - The speed of the meters have to be set at 19200 baud.
 - Other parameters to be used are default parameters. For information: Parity: even, Stop bit: 1, Do not use address 247".

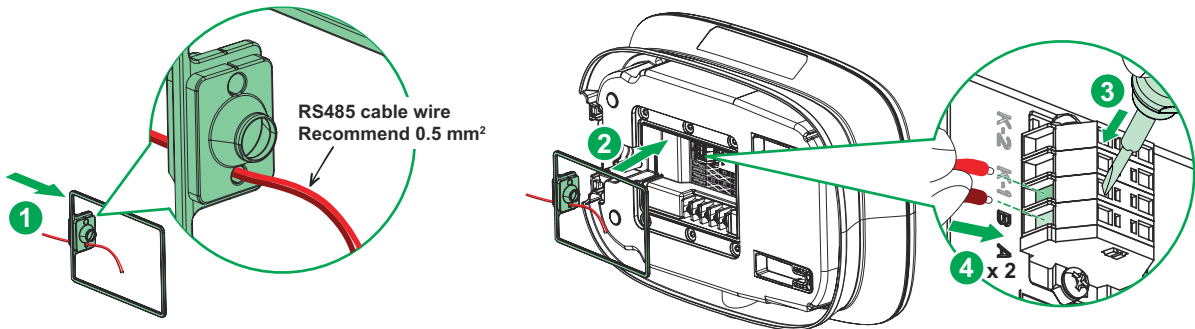

6.5 Secure Inspection Hatch



6 Connection

6.6 Clamp Power Cable

- Select clamp position according to power cable diameter

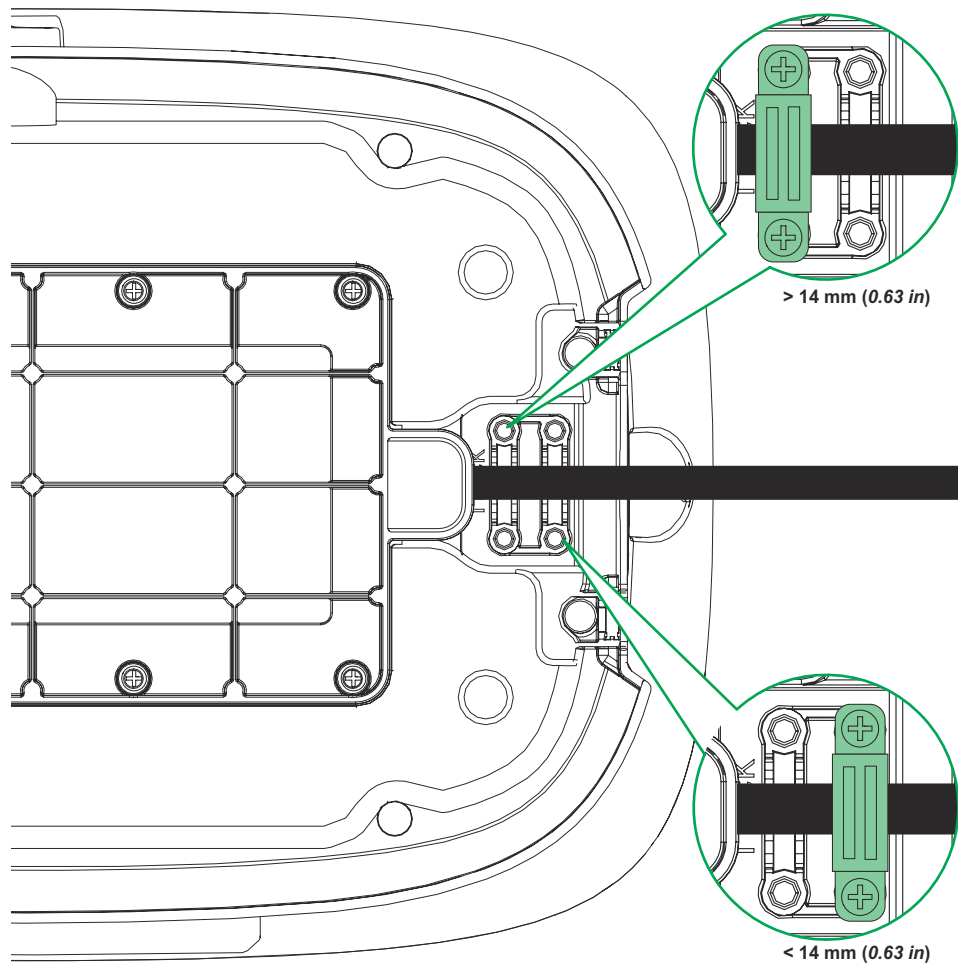

7 Installation

⚠️ ⚠️ DANGER

HAZARD OF ELECTRIC SHOCK, EXPLOSION OR ARC FLASH

- Disconnect power supply before working on this equipment.
 - Use a voltage tester of suitable rating.
 - Do not start the charging station if the ground resistance measured is greater than the threshold defined by the applicable law.
 - Install the over-current and residual current protections as described in the instructions and recommendations chapter (section "Operation", page 17).
 - Do not use a system which automatically resets the residual current circuit breaker.
- Failure to follow these instructions will result in death or serious injury.**

⚠️ WARNING

RISK OF DAMAGING THE CHARGING STATION

- Protect the charging station from dust and water while fixing the bracket.
- Attach the charging station to a flat surface.
- Use screws, washers and wall plugs suitable for the wall material.

Failure to follow these instructions can result in death, serious injury, or equipment damage.

7.1 Mark Installation Area

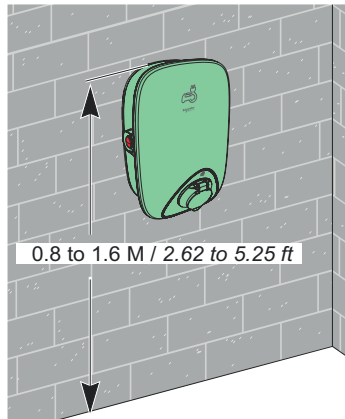
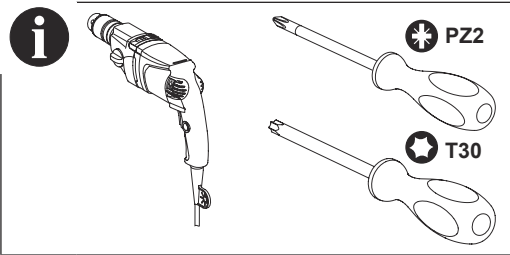

- Check the installation area before marking it on the wall. It is recommended to situate the top of the charging station between 0.8 to 1.6 m / 2.62 to 5.25 ft above the ground.

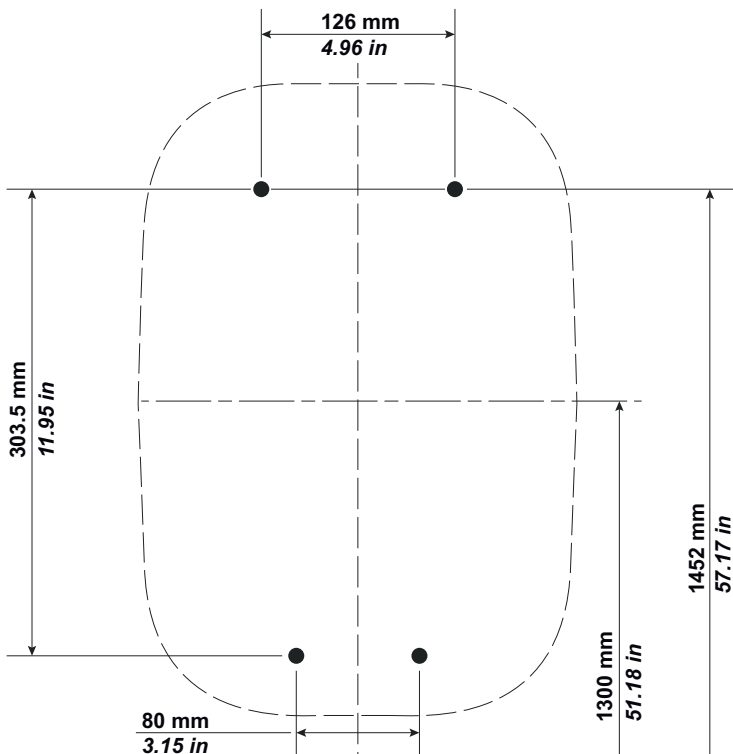

- Place the drilling template at a suitable height, and mark the support screws on the wall with a pencil.
- Ensure you allow sufficient space around the charging station to wind the cable and access the stop button (left-hand side).

⚠️ WARNING

HAZARD OF ELECTRIC SHOCK

Disconnect power supply.

Failure to follow these instructions can result in death, serious injury, or equipment damage.

Recommended installation procedure

1. Read EVlink Home's Instruction Sheet
2. Mark area using Installation Template sheet
3. Drill holes through template
4. Fix screws and bracket to holes
5. Wire upstream protection (section "Protection", page 7)
6. Wire shunt trip release (MNx) to charging station
7. Wire power supply to charging station
8. Secure charging station's inspection hatch
9. Clamp charging station's power cable
10. Mount charging station onto screws and bracket
11. Fix bracket to charging station
12. Install anti-tripping system (optional)
13. Inspect installation (section "Inspection", page 14)
14. Check stop button unlocked (section "Configuration", page 15)
15. Reconnect power supply

7 Installation

7.2 Drill, Fix and Mount

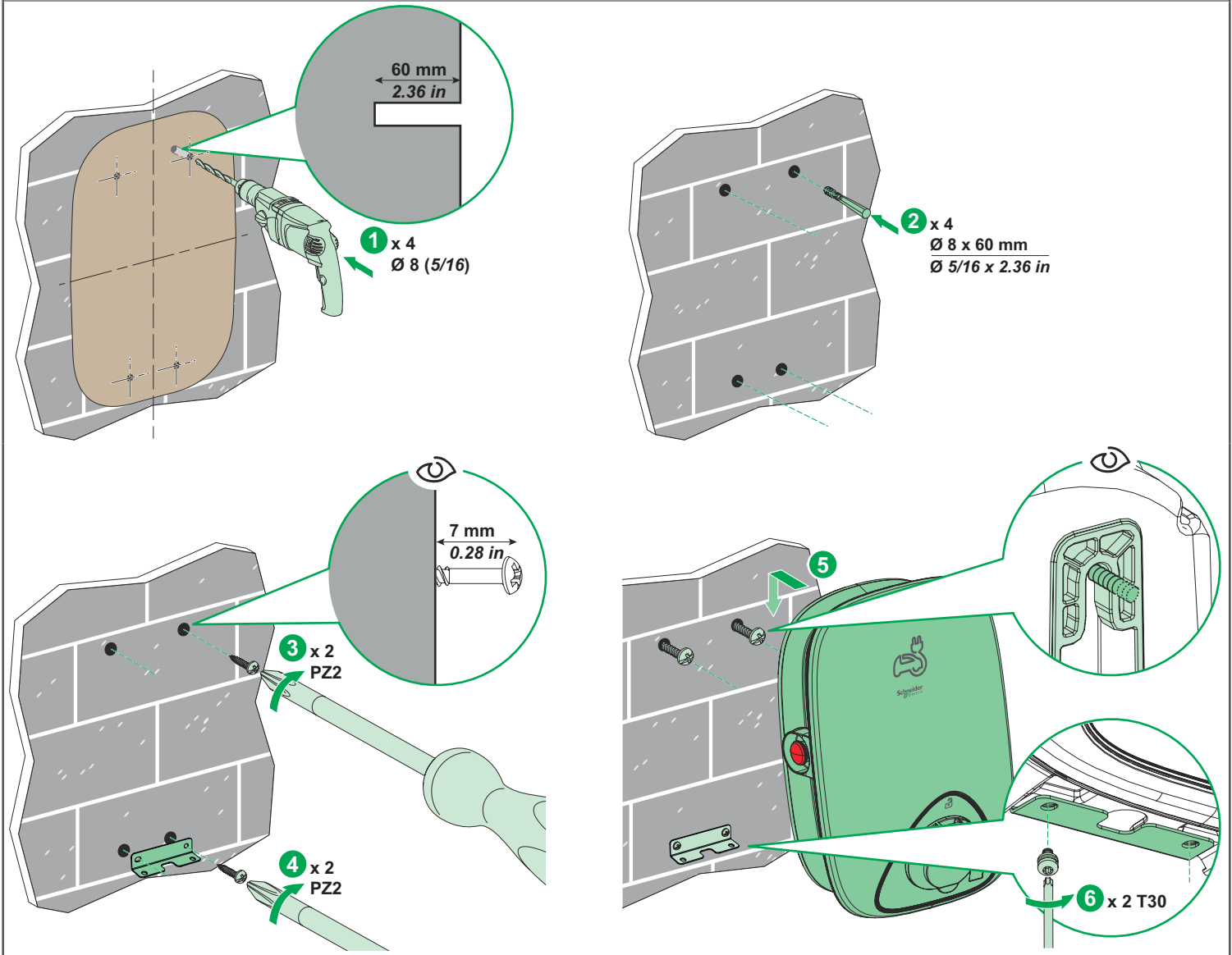

8 Inspection

⚠️ ⚠️ DANGER

HAZARD OF ELECTRIC SHOCK, EXPLOSION OR ARC FLASH

Wear suitable personal protective equipment (PPE) and follow all safety procedures.

Failure to follow these instructions will result in death or serious injury.

- Check that the inspection hatch is correctly screwed down.
- Ensure that the power cable is securely fastened by the crimping collar.
- Check that the cover of the charging station is intact and hasn't suffered any obvious mechanical damage or deformation.
- Check that the charging station is securely fastened to the wall.
- Check that nothing is impeding the connection of the charging cable to the charging station socket.

9 Configuration

- Check that the Stop Button is unlocked by rotating it 90° clockwise.

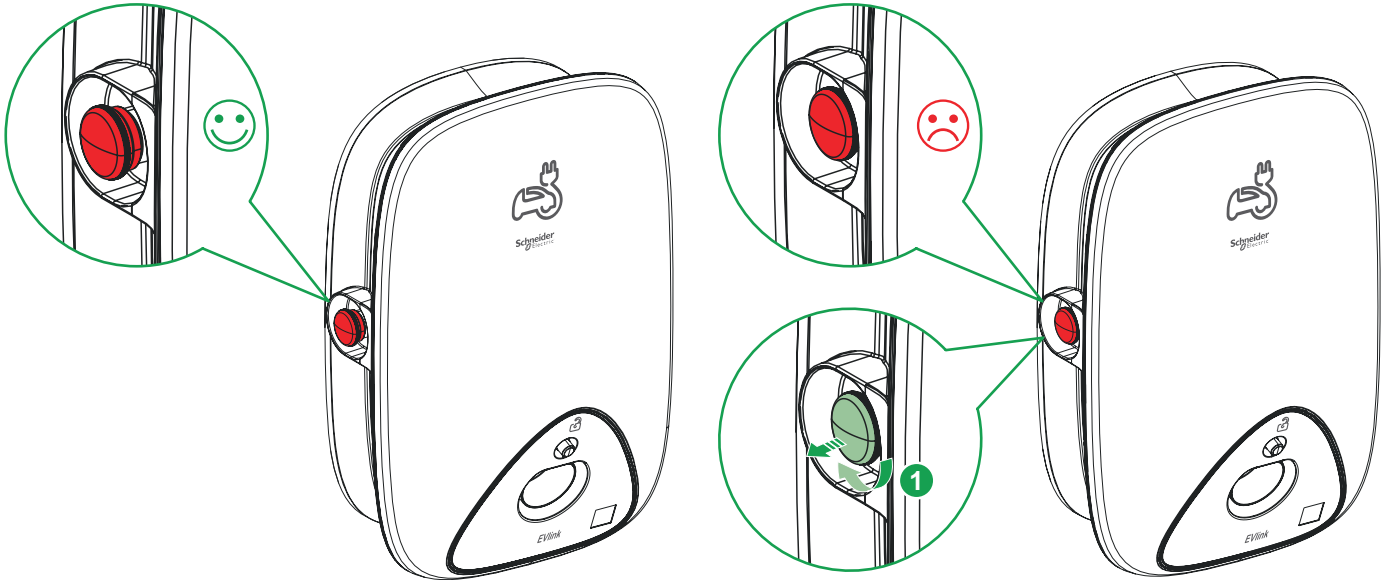

10 Cable Storage

⚡ ⚠ DANGER

HAZARD OF ELECTRIC SHOCK, EXPLOSION OR ARC FLASH

Regularly check the integrity of the cable.

Failure to follow these instructions will result in death or serious injury.

- Ensure that the charging connector and charging cable are securely stored between charging sessions.
- Wrap the charging cable around the charging station's cable trough.
- If the EVlink Home charging station and EVlink Home Smart charging station are installed indoors, protect the connector by covering it with the dust cap.
- If the EVlink Home charging station and EVlink Home Smart charging station are installed outdoors, store the connector by plugging it into the socket of the charging station.

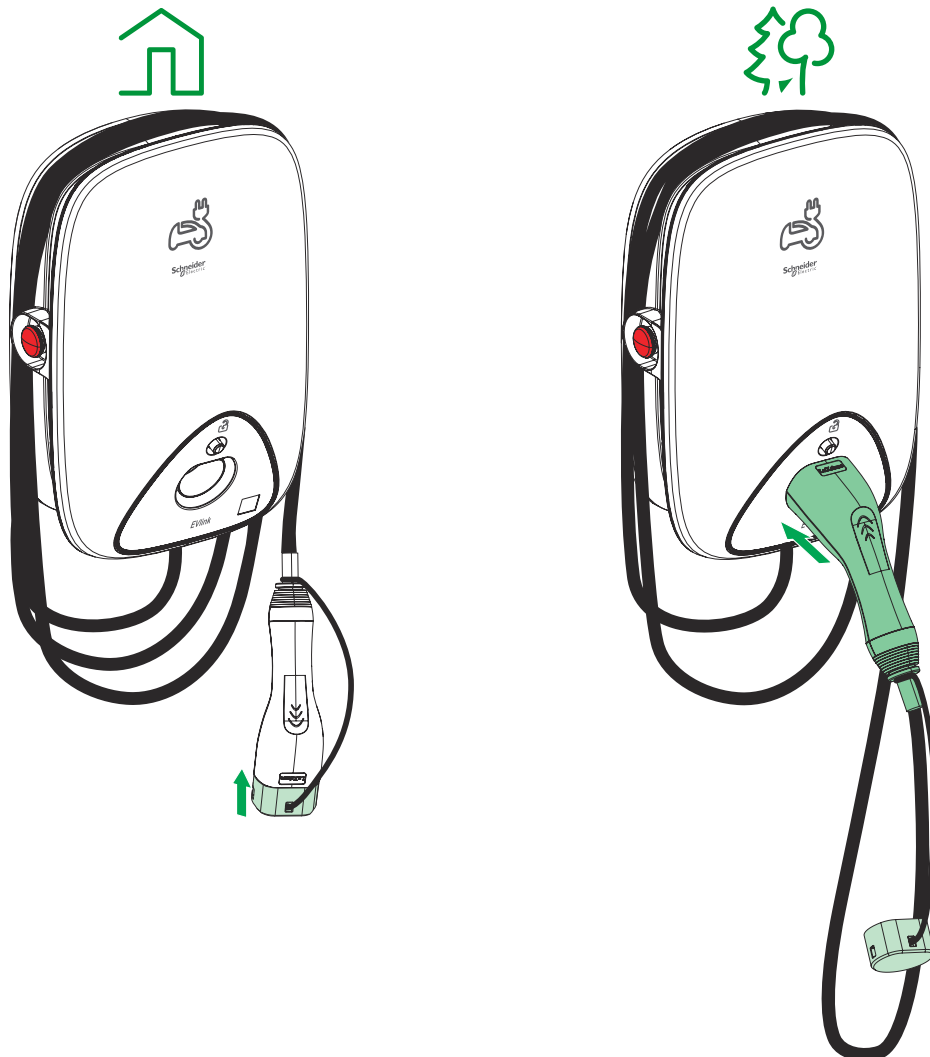



11 eSetup Commisioning App (For EVlink Home Smart Charging Station)

11.1 Charging Station Configuration with eSetup for Electrician App

GET IT ON









Schneider Electric Cloud

Download on the









eSetup
for commissioning



EVlink Home Smart Charger



Internet Router



Wiser home
for supervision

Wi-Fi Direct Wi-Fi LAN or Ethernet Network (RJ45 cable) WAN Access



11.2 Commissioning Steps

NOTICE

FIRMWARE UPGRADE



- Do not shut down the power during the Firmware upgrade.
- Failure to follow these instructions can result in equipment damage.
- The whole Firmware upgrade duration will take 5 to 10 minutes.
- For your information, eSetup will disconnect from EVlink Home Smart charging station during the process.

1. Download and launch eSetup

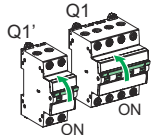

Access the App Store or Google Play and download the eSetup for electrician app.

2. Power on the charging station

Power on the EVlink Home Smart charging station to activate the Wi-Fi access point. The Wi-Fi access point will remain active for 4 minutes after power on.

3. Connect with eSetup

Start the eSetup for electrician app and select EVlink Home Smart in the menu. The default eSetup PIN code to connect to EVlink Home Smart charging station is 123456.

4. Setup the charging station









1
2
3
4
5

Network Settings Electrical Settings Device Settings Supervision Settings Handover to client



Follow the instructions in eSetup for electrician app.

5. Restart the charging station

The EVlink Home Smart charging station must be restarted at the end of the commissioning. The charging station will connect to the internet router (after 4 minutes for Wi-Fi).

6. Connected

The LED turns solid green when the charging station is connected to the Internet router. The charging station is now ready to be operated by the homeowner with the Wiser application.

Notes:

Refer to privacy notices made available to you in the Wiser application or supervision tool, as applicable.

11.3 Charging Station PIN code reset

- PIN Code reset:
 - If the charging station PIN code is lost, use the Reset PIN option in eSetup.

12.1 Connecting the Electric Vehicle Charging Station

- Connect the charging cable's plug into the Electric Vehicle charging station's socket.
- Connect the charging cable's connector into the Electric Vehicle's inlet.
- The charge's LED indicator will change from a solid green to pulsing blue.

12.2 Disconnecting the Electric Vehicle

⚠ WARNING

RISK OF INJURY

Do not use brute force to unplug the charging connector from the Electric Vehicle as it is mechanically locked .
Failure to follow these instructions can result in death, serious injury, or equipment damage.

- Stop the charging session via the Electric Vehicle to unlock the connector.
- Unplug the charging station's connector from the Electric Vehicle's inlet.
- Wind the charging cable around the Electric Vehicle charging station's winding trough.

12.3 Remote supervision with Wis(er) (For EVlink Home Smart Charging Station)

- Wis(er) Home lets you add, configure, control and schedule your connected Schneider Electric devices from anywhere.



Reading the full device guide online

- Scan the QR code and choose your language for related market
 - for complete information about the device, including operation, configuration and using the product with a Wiser system.



United Kingdom
France
Germany



Denmark



Sweden
Finland
Spain
Portugal



Norway



Australia



New Zealand

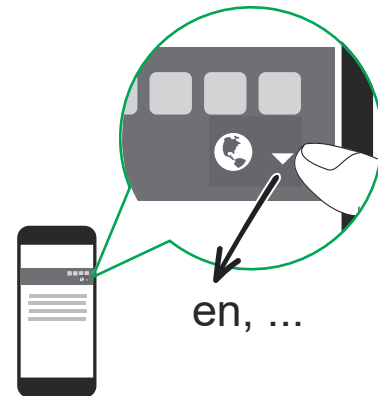

13 Charging Station Status Indicators

LED color	LED behaviour	Charging station Status
Green	Solid	Standby
Green	Blinking	Firmware upgrade in process
Light Green	Pulsing	Ready to charge, not connected to the Internet, refer to section "Basic Troubleshooting", page 18
Blue	Solid	Charge complete (< 1 A after 20 minutes)
Blue	Pulsing	Charging
Blue	Blinking	Charging suspended
Purple	Solid	Pairing status for Anti-tripping device
Red	Solid	Please refer to section "Basic Troubleshooting", page 18

14 Basic Troubleshooting

Symptom	Possible causes and solutions
Connector plugged into Electric Vehicle but not charging, LED illuminated solid green	<ul style="list-style-type: none"> ■ Verify that the connector was inserted properly by unplugging and plugging it back into the Electric Vehicle's socket. ■ Verify the charging sequence by following the procedure described in section "Operation", page 17.
Connector plugged into Electric Vehicle but not charging, LED illuminated Blinking blue	<ul style="list-style-type: none"> ■ Verify that you do not have a schedule in progress through the supervision app (only for Smart version) that prevents charging the car. ■ Verify that you do not have a schedule in progress through your car that prevents charging the car. ■ In case you have installed an anti-tripping device. The anti-tripping device limits the maximum power draw of the EVlink Home charging station and can completely stop the charge to ensure the continuity of the electrical distribution under all conditions. Reduce the home load to have at least 9A current available per phase to restart charging the car. <ul style="list-style-type: none"> □ Be sure you have enough power in your electricity subscription for charging the car and for the house loads. You probably need to increase the electricity subscription of your electrical installation.
Charging station's LED slowly pulsing light green (EVlink Home Smart charging station ONLY)	<ul style="list-style-type: none"> ■ Reboot the EVlink Home Smart charging station and wait 10 seconds before energizing it. ■ The EVlink Home Smart charging station is not connected to the Internet when using Wi-Fi: <ul style="list-style-type: none"> □ Verify that you have connected the EVlink Home Smart charging station to a 2.4 GHz Wi-Fi with WPA2 password □ Verify that the SSID and password are correct. □ In case the Wi-Fi signal is too weak: connect the charging station with Ethernet cable, or add a Wi-Fi range extender.
Charging station's LED illuminated red	<ul style="list-style-type: none"> ■ Verify that the Stop Button isn't locked by rotating it 90° clockwise to unlock it. ■ If not, switch off the power supply to the charging station, unplug the connector from the Electric Vehicle, reconnect the power supply, wait for the charging station to become ready (LED illuminated solid green), before reconnecting the connector to the Electric Vehicle. ■ Failing that, check that the power supply is securely wired to the charging station's PE (Protective Earth) terminal.
Charging station's LED off	<ul style="list-style-type: none"> ■ No power supply. Switch off the power supply to the charging station. The charging station is possibly damaged. Please contact Schneider Electric's Customer Care Centre.

15 Wireless Feature Declaration

For Europe (where the CE marking is applicable):

Hereby, Schneider Electric Industries, declares that this electric vehicle charging station EVlink Home Smart is in compliance with the essential requirements and other relevant provisions of Radio Equipment Directives RED 2014/53/EU.

The EU declaration of conformity for EVlink Home Smart offer (EV22080801) can be downloaded on: se.com/docs.

- Wi-Fi:
 - Operating frequency bands: 2412 MHz – 2472 MHz
 - Maximal RF output power: less than 20 dBm (18.25 dBm)

For UK:

Hereby, Schneider Electric Industries, declares that this electric vehicle charging station EVlink Home Smart is in compliance with the essential requirements and other relevant provisions of Radio Equipment Regulation SI 2017 No. 1206.

The UK declaration of conformity for EVlink Home Smart offer (EV22080801-UK) can be downloaded on: se.com/uk/docs.

- Wi-Fi:
 - Operating frequency bands: 2412 MHz – 2472 MHz
 - Maximal RF output power: less than 20 dBm (18.25 dBm)

16 Recycle



The packaging materials from this equipment can be recycled. The product and all accessories marked with this symbol are electrical and electronic components that must be disposed of separately from household waste. Please help protect the environment by disposing waste in appropriate containers. Thank you for helping to protect the environment.

17 Warranty

Do not open the charging station or remove the cover.
Contractual warranty: 18 months.

